

The Cambridge Balustrade System

Marble & Resin Composite Product Manufactured By Pacific Columns.

Roof Top Installations Straight Applications

Product Specifications:

Assembled baluster rail system height is 28-1/2" in height.

Balusters

| | <u>4" Sphere Code*</u> | <u>Typical Spacing</u> |
|--|------------------------|------------------------|
| Rail System Height: | 28-1/2" | 28-1/2" |
| Spacing: | 1-1/4" | 3" |
| Spacing On Center: | 6-3/4" | 8-1/2" |
| Balusters Needed per Linear Foot [LF] | 1.778 | 1.37 |
| Weight per LF Baluster, Rail & Hardware: | 65 lbs. | 56 lbs. |

Newel Posts

| | <u>Peaked</u> | <u>Rounded Cap</u> |
|------------------------------|---------------|--------------------|
| 12" Roof Top Newel Post | 118.25 lbs. | 119.75 lbs. |
| 12" Roof Top Half Newel Post | 59.13 lbs. | 119.75 lbs. |

Ball Tops

Large Ball Top [BT-08] 16 lbs.

Note: Ball Tops are to be used only with rounded cap newel posts.

*4" Sphere Code spacing requires that a 4" ball cannot fit through any spacing between balusters. Customers are responsible for local code adherence.

Balusters

Railings

Straight Applications Balusters

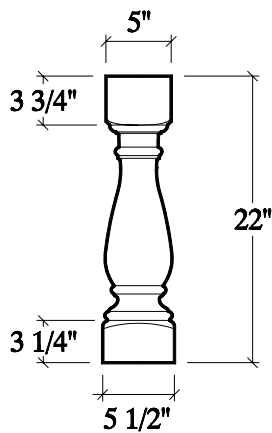

BC520-22

Top Railing

RT501

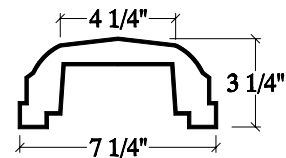

Bottom Railing

RB505

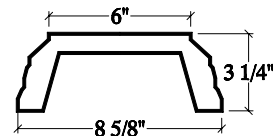

The Cambridge Balustrade System

Marble & Resin Composite Product Manufactured By Pacific Columns.

Roof Top Installations

Newel Posts

12" Roof Top Newel Posts

12" Roof Top Half Newel Posts

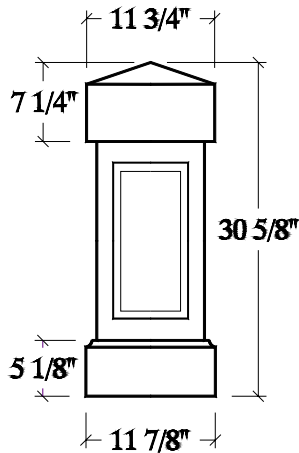

NPP512 - Peaked

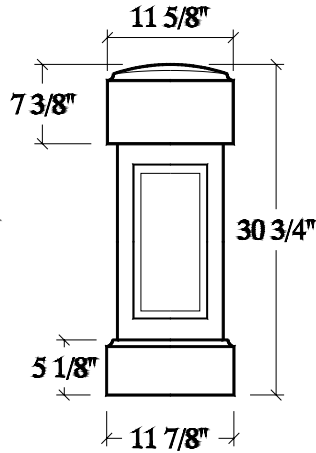

NPP306-H - Rounded

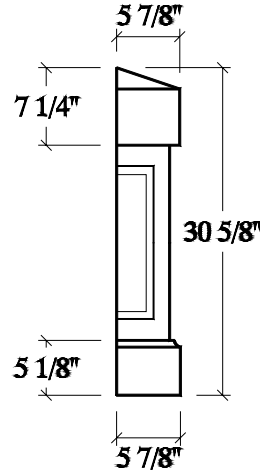

NPP506-H - Peaked

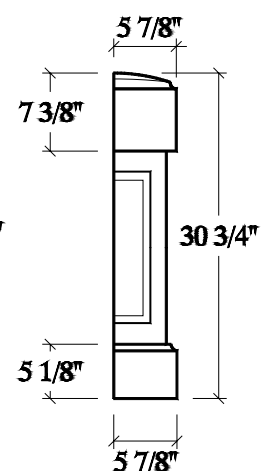

NPR506-H Rounded

Ball Caps

Large Ball Cap

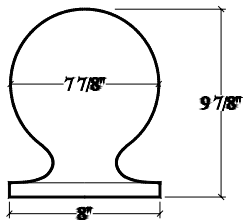

BT-08

Pacific Columns

1040 S. Melrose
Placentia, CA 92870
1.800.294.1098 or 1.714.630.4550
1.714.630.4549 Fax
www.pacificcolumns.com